

Złączka równoprzelotowa (dwuzłączka)
Coupler • Муфта соединительная

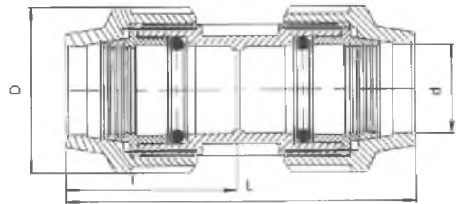

Nr kat.	d x d	D	I	L	Opakowanie	
					Małe	Duże
ZPE20	20 x 20	43	51	100	45	110
ZPE25	25 x 25	50	57	117	28	70
ZPE32	32 x 32	58	54	131	45	105
ZPE40	40 x 40	74	76	155	25	60
ZPE50	50 x 50	85	88	180	15	32
ZPE63	63 x 63	99	91	187	12	24
ZPE75	75 x 75	129	136	278	-	-
ZPE90	90 x 90	155	154	315	-	-
ZPE110	110 x 110	183	205	422	-	-

Redukcja skręcana ZRHDPEs Reducing coupler • Муфта переходная

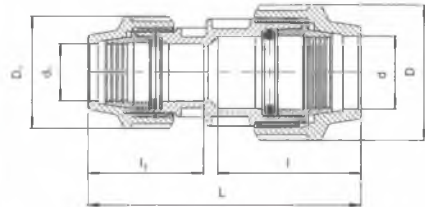

Opakowanie Opakowanie

Nr kat.	d x d1	D	D1	I	I1	L	Małe	Duże
ZRE2520T	25 x 20	50	43	56	52	112	38	80
ZRE3220T	32 x 20	58	43	64	52	121	28	72
ZRE3225T	32 x 25	58	50	64	55	125	54	126
ZRE4020T	40 x 20	74	43	73	52	134	36	75
ZRE4025T	40 x 25	74	50	73	55	138	36	72
ZRE4032T	40 x 32	74	58	73	62	145	30	70
ZRE5025T	50 x 25	85	50	85	55	151	24	60
ZRE5032T	50 x 32	85	58	85	62	157	20	50
ZRE5040T	50 x 40	85	74	85	73	168	15	37
ZRE6332T	63 x 32	99	58	93	62	163	18	36
ZRE6340T	63 x 40	99	74	93	73	174	12	29
ZRE6350T	63 x 50	99	85	93	88	185	12	24

Trójnik równoprzelotowy Y 45°
45° tee • Тройник соединительный

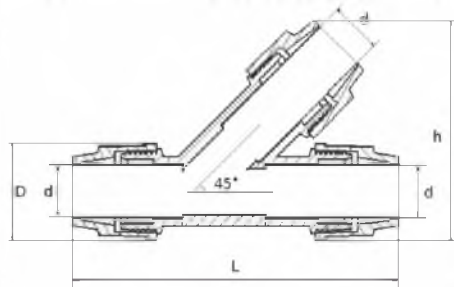

Opakowanie Opakowanie

Nr kat.	d x d x d	D	L	Małe	Duże
TPY40	40 x 40 x 40	74	245	10	20

Trójnik równoprzelotowy TRHDPFs
90° tee • Тройник соединительный

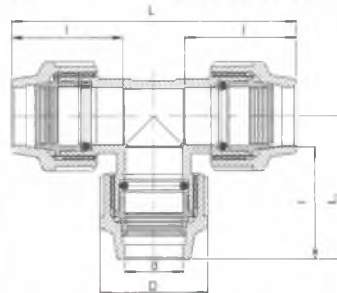

Nr kat.	d x d x d	D	I	L ₁	L	Opakowanie	
						Małe	Duże
TPE20T	20 x 20 x 20	43	52	63	126	25	60
TPE25T	25 x 25 x 25	50	59	73	146	17	45
TPE32T	32 x 32 x 32	58	66	85	169	25	58
TPE40T	40 x 40 x 40	74	80	100	200	15	32
TPE50T	50 x 50 x 50	85	92	117	235	7	17
TPE63T	63 x 63 x 63	99	95	127	253	5	12

Uszczelka do rur pustych URHDPEr
End plug • Заглушка конца трубы

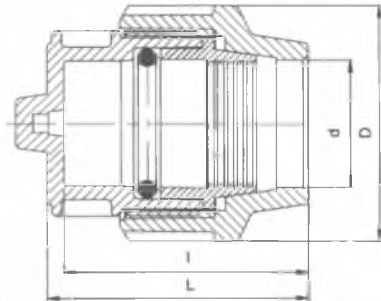

Nr kat.	d	D	I	L	Opakowanie	
					Małe	Duże
ZAS20T	20	43	51	69	70	140
ZAS25T	25	50	54	77	50	125
ZAS32T	32	58	62	88	30	80
ZAS40T	40	74	74	98	45	90
ZAS50T	50	85	85	110	26	66
ZAS63T	63	99	94	121	16	42

Uszczelka do rur z wentylem URHDPEw

End plug with valve •

Заглушка конца трубы с вентилем

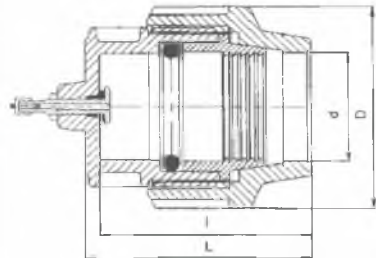

Opakowanie Opakowanie

Nr kat.	d	D	I	L	Małe	Duże
ZAZ20T	20	43	51	69	70	150
ZAZ25T	25	50	54	77	60	140
ZAZ32T	32	58	62	88	50	110
ZAZ40T	40	74	74	98	45	100
ZAZ50T	50	85	85	110	40	90
ZAZ63T	63	99	94	121	70	147

Uszczelka do rur z kablem URHDPEK
End plug with cable •
Заглушка конца трубы с выходом на кабель

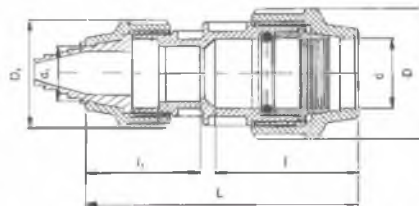

Opakowanie Opakowanie

Nr kat.	d x d	D	D₁	I	I₁	L	Małe	Duże
ZAK20T	20 x 20	43	50	56	52	112	39	90
ZAK25T	25 x 25	50	50	51	52	117	39	80
ZAK32T	32 x 32	58	50	64	55	125	39	80
ZAK40T	40 x 25	74	50	73	55	138	34	78
ZAK50T	50 x 25	85	50	85	55	151	26	65



Narzędzie do fazowania rur (fazownik do rur)

Narzędzie, które w łatwy sposób fazuje zewnętrzną średnicę rury z tworzyw sztucznych PE, PP, PPR o średnicy 23-63 mm rur, wykorzystywanych do skręcania i zgrzewania w instalacjach zewnętrznych i wewnętrznych. Fazownik do rur jest prostym narzędziem ręcznym, który znacznie skraca czas przygotowania rur do prostego łączenia.

Chamfering tool

A tool that facilitates the easy chamfering of the external diameter of PE, PP and PPR pipes with a diameter of 20-63 mm and of pipes used in screwing and welding in external and internal instalations. Our pipe chamfering tool is a simple manual tool that greatly reduces the time needed to prepare pipes for simple coupling.

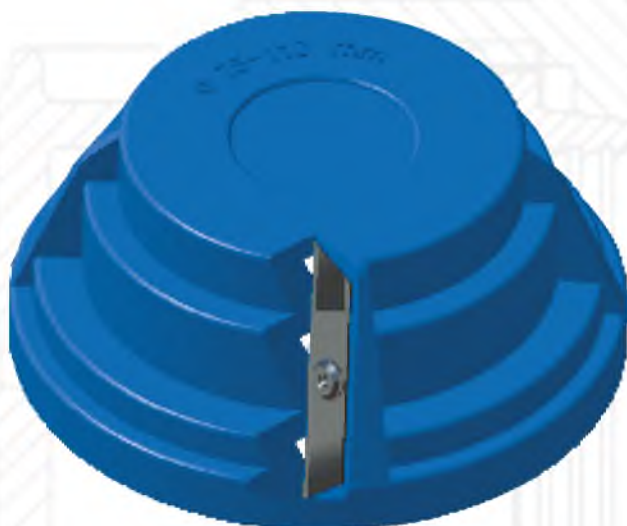

Narzędzie do fazowania rur (fazownik do rur)

Narzędzie, które w łatwy sposób fazuje zewnętrzną średnicę rury z tworzyw sztucznych PE, PP, PPR o średnicy 75-110 mm rur, wykorzystywanych do skręcania i zgrzewania w instalacjach zewnętrznych i wewnętrznych. Fazownik do rur jest prostym narzędziem ręcznym, który znacznie skraca czas przygotowania rur do prostego łączenia.

Chamfering tool

A tool that facilitates the easy chamfering of the external diameter of PE, PP and PPR pipes with a diameter of 75-110 mm and of pipes used in screwing and welding in external and internal instalations. Our pipe chamfering tool is a simple manual tool that greatly reduces the time needed to prepare pipes for simple coupling.